

Saramonic

2.4GHz Wireless Smart Microphone with Touchscreen

2.4GHz无线触屏智能麦克风

BlinkMe

User Manual
用户手册

Statement

Please read this manual carefully before using and strictly operate and store it in accordance with the instructions. Please save the manual for your future reference. If you need further assistance than the user manual, please consult your retailer for help or email us: info@saramonic.com

- Non-professional teardown is strictly prohibited.
- Please keep it away from heat sources such as heaters or ovens.
- Do not remove the battery without professionals' help.
- Please clean the device with only a soft, dry cloth.
- When using and storing, please keep away from the dust and moisture.

General Introduction

The Saramonic BlinkMe, a professional dual channel wireless microphone system with touchscreen, which can be used with different magnetic accessories. This ultra-portable and incredibly lightweight mic system boasts universal compatibility with tablets, laptops, cameras, recorders, mixers, and other audio/ video recording devices. Ideal for content creators, filmmakers, journalists, vloggers, live streaming, and so much more.

- Quick and easy to operate the intuitive touchscreen
- Separate OS without having to rely on any application
- Smart onboard recording capability
- Also available in 48kHz HD audio when noise reduction enabled
- The receiver can charge the transmitter(s)
- Customize the wallpaper for the transmitter through the Saramonic App
- A magnetic system with several accessories
- Flexibly attach or remove the transmitter to or from clothes

Overview

Transmitter

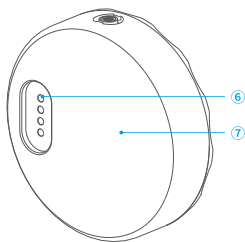
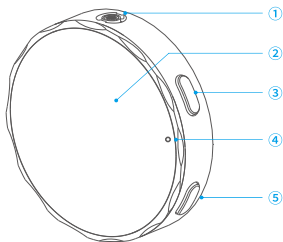

① Microphone Capsule

② Touchscreen

③ Power Button

- Press and hold for 3 seconds power on or off.
- Press twice to lock or unlock the screen.

④ LED Indicator

Indicates the status of the transmitter when its screen is turned off.

Indicator	Status
Blinking blue slowly	Unpaired
Blinking blue quickly	Pairing
Static blue	Paired successfully
Blinking red slowly	Mute
Blinking red quickly	Low battery
Static red	Charging
Red light off	Fully charged

⑤ NR Button

- Press to enable or disable noise reduction.
- Press twice to enable or disable onboard recording.
- Press and hold for 1.5 seconds to mute or unmute the microphone.

⑥ Contacts

⑦ Magnet

Receiver

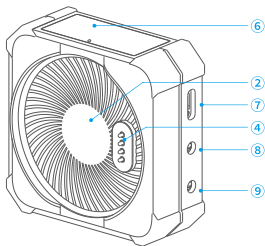
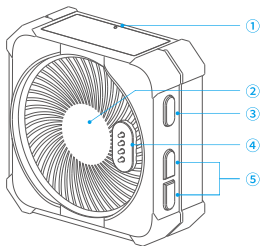

① LED Indicator

Indicates the status of the receiver when its screen is turned off.

Indicator	Status
Blinking blue slowly	Unpaired
Blinking blue quickly	Pairing
Static blue	Paired successfully
Blinking red quickly	Low battery
Static red	Charging
Red light off	Fully charged

② Magnet

③ Power Button

- Press and hold for 3 seconds power on or off.
- Press twice to lock or unlock the screen.

④ Contacts

⑤ +/- Button

Press to turn up or turn down the output gain level of the receiver in 3dB increments from -12dB to +12dB.

⑥ Touchscreen

⑦ USB-C Port

Used for charging the receiver and transferring data.

⑧ 3.5mm Monitor Port

Connect your headphone to monitor the audio output.

⑨ 3.5mm Auto-Sensing Output (TRS/TRRS)







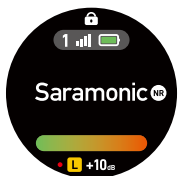



For analog audio output to a camera, smartphone or mixer, etc.

Touchscreen Operations

















Transmitter











- From the Home screen, press the power button to turn the screen on or off.
- To return to the Home page from any other pages, press the power button once.
- Press the power button twice to lock or unlock the screen and return to the Home page.

	Indicates the screen is locked or unlocked. 💡 It is recommended that you can lock your screen to avoid accidental taps during a recording. By default, the device returns to the Home screen automatically when the screen is locked.
	Indicates the current wireless signal strength between transmitter 1 and the receiver. A gray icon indicates a failed connection.
	Indicates the battery level of the transmitter.
	Indicates the noise reduction is enabled.
	Indicates the audio input level. 💡 Reduce the transmitter gain accordingly when the volume bar turns red.
	Indicates the microphone is muted.
	Indicates the onboard recording is enabled.
	Indicates the input gain of the transmitter.
	Indicates the left or right sound channel.
	Indicates Stereo, Mono or Safety Channel mode.

From the Home screen, swipe up from the bottom of the screen to access device settings. Swipe up or down to select Onboard Recording, Noise Reduction, TX Gain, Brightness, Display and Settings. From device settings, tap  to return to the previous screen.

	 REC Protection	When the function is activated, the onboard recording can only be disabled by operating the screen instead of pressing the button.
	 Auto Recording	When the function is activated, the onboard recording will be enabled automatically as soon as the transmitter is switched on.
	 Bit Depth	Tap to set bit depth to 16bit or 24bit.
	<input type="radio"/> Original sound	Default to original sound. Select original sound or HD noise reduction on demand.
	<input type="radio"/> HD noise reduction	
		Drag the Gain control slider to adjust the input gain level of the transmitter in 1dB increment from -12dB to +12dB. Note that the transmitter gain will affect the volume of the recorded audio.
		Drag the Brightness slider to adjust the screen brightness.
	<input type="radio"/> Power saving	By default, when enabled, this will turn screen brightness to 50% and turn the screen off after 10 seconds of inactivity.
	<input type="radio"/> Always on	When enabled, the screen will always stay on.
	<input type="radio"/> Auto screen off	Scroll up or down to set the time when the screen is turned off automatically.
	 Pairing	Tap to access the page where you can pair the transmitter with the receiver.
	 Language	Tap to choose a language.
	 Date & Time	Tap to set the date and time for the recording files.
	 Reset	Tap to restore the transmitter to its factory default settings, which resets everything except the onboard recording files and current pairing status.
	 Version	Tap to view the firmware version and serial number of the transmitter.
	 Cert info	Tap to view certification information.

From the Home screen, swipe down from the top of the screen to display Quick settings.

 Power saving	Tap to switch.
 Always on	
 Auto screen off	
 Microphone muted	Tap to switch.
 Microphone unmuted	
 Onboard recording enabled	Tap to switch.
 Onboard recording disabled	
 Settings	Tap to quickly access.

Themes

Choose a theme you want to be applied to your Home screen.

1. From the Home screen, touch and hold the screen.
2. Swipe up or down to view nine types of default themes.
3. Tap the screen to apply the selected theme.







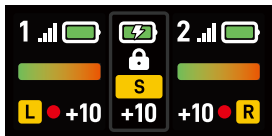



If you want, you also can customize the wallpaper for your Home screen on the Saramonic app. To download the app, scan the QR code on the screen.



















Receiver









- To return to the Home page from any other pages, press the power button once.
- Press the power button twice to lock or unlock the screen and return to the Home page.

	<p>Indicates the screen of the receiver is locked or unlocked. 💡 It is recommended that you can lock your screen to avoid accidental taps during a recording. By default, the device returns to the Home screen automatically when the screen is locked.</p>
	<p>Left and right sides: The transmitter's battery level. Middle of the screen: The receiver's battery level.</p>
	<p>Indicates that the receiver is charging.</p>
	<p>Indicates that the transmitter is being charged by the receiver.</p>
	<p>Indicates that the receiver is in Mono, Stereo, or Safety Channel mode.</p>
<p>+10</p>	<p>Left and right sides: The transmitter's input gain. Middle of the screen: The receiver's output gain.</p>
<p>1 .lll</p>	<p>Indicates the wireless signal strength between transmitter 1 and the receiver.</p>
<p>2 .lll</p>	<p>Indicates the wireless signal strength between transmitter 2 and the receiver. If there's no second transmitter connected, this icon will not be displayed.</p>
	<p>Indicates the audio input level. 💡 Reduce the transmitter gain accordingly when the volume bar turns red.</p>
<p>L R</p>	<p>Indicates the left or right sound channel. 💡 Under Stereo mode, transmitter TX1 matches the left channel, transmitter TX2 matches the right channel.</p>
	<p>Indicates the onboard recording is enabled.</p>
	<p>Indicates the microphone is muted.</p>

From the Home screen, swipe down from the top of the screen to access device settings. Swipe left or right to select Recording Mode, RX Gain, TX Gain, Display and Settings. From device settings, swipe up from the bottom of the screen to return to the previous screen.

	 Mono	Signal from the transmitter or both transmitters can be mixed together and recorded identically to left and right channels.
	 Stereo	Signals from each transmitter can be recorded to a separate channel.
	 Safety Channel	Similar to Mono mode, the audio of the right channel will be recorded in -6dB in case distortion in your recordings.
		Drag the Gain control slider to adjust the output gain level of the receiver in 1dB increment from -12dB to +12dB. The receiver gain can be reduced if the sound is distorted.
		In the paired state, tap left or right to set TX1 or TX2. Drag the Gain control slider to adjust the input gain level of the transmitter(s) in 1dB increment from -12dB to +12dB. Note that the transmitter gain will affect the volume of the recorded audio.
	 Power saving	By default, when enabled, this will turn screen brightness to 50% and turn the screen off after 10 seconds of inactivity.
	 Always on	When enabled, the screen will always stay on.
	 Pairing	Tap to pair the receiver with the transmitter(s).
	 Brightness	Tap it, then drag the Brightness slider to adjust the screen brightness.
	 Language	Tap it, then swipe left or right to choose a language.
	 Reset	Tap to restore the receiver to its factory default settings, which resets everything except the current pairing status.
	 Version	Tap to view the firmware version and serial number of the receiver.
	 Cert info	Tap to view certification information.

To access transmitter TX1 or TX2 settings from the Home screen, swipe up on the left or right side of the screen.

 Onboard recording enabled	Tap to switch.
 Onboard recording disabled	
 Microphone muted	Tap to switch.
 Microphone unmuted	
 Memory	Indicates the remaining available time for recording. Tap to access a submenu.
 Format	Tap to erase the onboard recording files of the transmitter.

Using BlinkMe

Transmitter

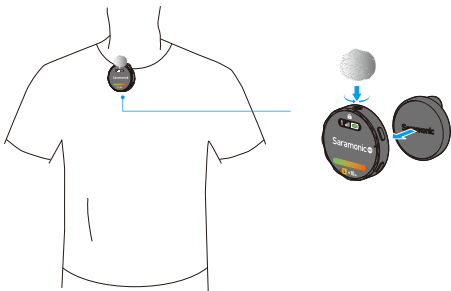

Use the magnetic clip to attach the transmitter to clothes.

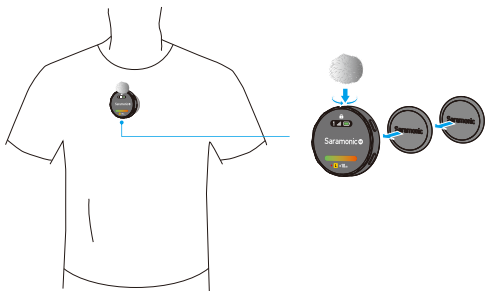

Use the magnets to attach the transmitter to clothes.

Receiver

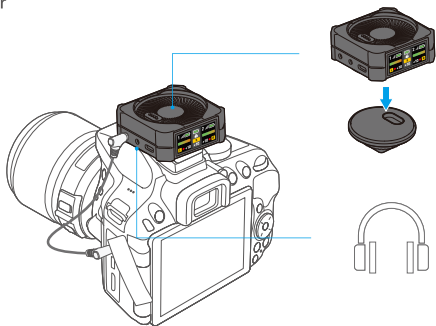

1. Connect a camera, a smartphone or a laptop to the 3.5mm auto-sensing audio output of the receiver with an adapter cable.
2. Plug your headphones for audio monitoring as your need.

 If the camera you used was SONY ZV-1, ZV-1 II, or ILCE-7C, please mount the included ZV-1 adapter on your camera first.

How to Pair

The transmitter and receiver are paired by default. If they are disconnected, please tap the screens of the transmitter and receiver to enter Settings, and then tap "Pair" to reconnect.

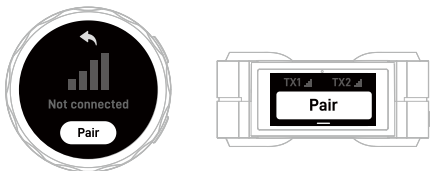

1. When both TX1 and TX2 need to be paired with RX, operate the transmitter first, and then operate the receiver.
2. If the screen of a device is failed to operate, press and hold the power button for 18 seconds to force the shutdown of the device, and then press and hold the power button for 3 seconds to turn the device on.
3. Due to the 2.4GHz wireless frequency is widely used, the signal may be easily attenuated or interfered. Please try to avoid obstacles while using, such as walls and buildings. And keep away from the devices with 2.4GHz frequency, such as high-power Wi-Fi antennas, radios, etc.

How to Charge

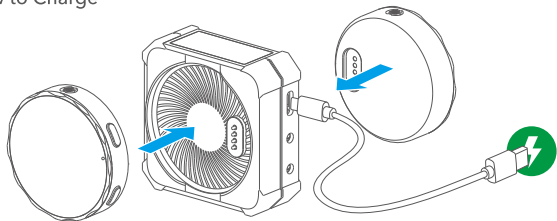

1. To charge the transmitter(s), please place it(them) on the receiver.
If the receiver reaches its safe battery level, it will stop charging the transmitter(s).
2. Use the included USB-A to USB-C cable to charge the receiver when the battery is low.

Audio Output for Dual Devices

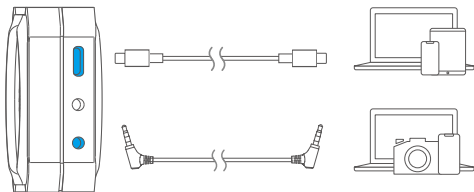

To output audio simultaneously, connect the receiver to two devices via the 3.5mm auto-sensing output or USB-C output using a correct cable.

Onboard Recording

- The memory can store up to 22 hours of recording at the 48kHz/16bit sampling rate. The memory can store up to 15 hours of recording at the 48kHz/24bit sampling rate.
- The file will be automatically split after 30 minutes of recording, making it easy to quickly find your desired recording segment.
- By default, the recording files are named in the format "DATE-TIME.WAV". Up to 999 recording files can be created.
- If the memory is full, the original file will be automatically overwritten with the latest file from the beginning.

💡 Note that in this mode, the "mute" function will not affect the onboard recording.

Loading Files

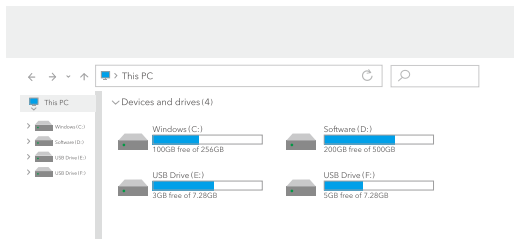
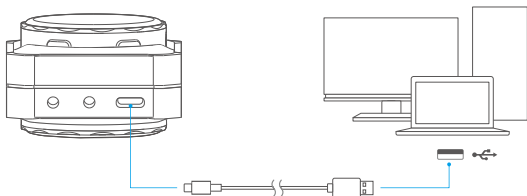

Place the transmitters on the receiver, and then connect a laptop to the receiver's USB-C port to read the recording files of TX1 and TX2.(You can rename the device in the Saramonic app.)

Specifications

Display	TFT
Transmission Type	2.4GHz digital frequency
Modulation	Digital modulation
Polar Pattern	Omnidirectional
Antenna	In-built antenna
Operating Range (without obstacles)	328' (100m)
RF Output Power	< 10mW
Sampling Rate	48KHz
Frequency Response	20Hz-20KHz
Signal-to-Noise Ratio	>80dB
Maximum SPL	110dB SPL
Sensitivity	-39±2dB
Audio Input Connector	TX: In-built condenser microphone
Monitoring Connector	RX: 3.5mm monitor port
Audio Output Connector	RX: 3.5mm auto-sensing output (TRS/TRRS)
Power Requirements	In-built rechargeable lithium-ion battery
Battery Specification	TX: 3.85V/495mAh RX: 3.7V/1600mAh
Charging Connector	TX: Charging contacts RX: USB-C
Charging Time	RX: Approx. 2.5 hours (using 5V/2A charger)
Battery Life	TX: Approx. 5 hours (onboard recording enabled) Approx. 8 hours (onboard recording disabled) RX: Approx. 24 hours (One TX fully charged)
Memory	TX: 8GB
Weight	TX: 1.06oz (30g) RX: 2.47oz (70g)
Dimensions	TX: $\varnothing 1.85 \times 0.49''$ ($\varnothing 47 \times 12.5\text{mm}$) RX: $2.23 \times 2.23 \times 0.99''$ ($56.6 \times 56.6 \times 25.2\text{mm}$)
Operating Temperature	0°C to +50°C
Storage Temperature	-10°C to +50°C

Troubleshooting

If you encounter problems when using the unit, please refer to the following checklist before contacting technical support. If the problem cannot be solved, please contact the dealer's after-sales service department.

- **If there is no sound from the unit or no sound when connected to an external device**
 - ① Make sure that the connecting cable between the product and the device is not loose.
 - ② Make sure the gain and volume are not turned to minimum.
 - ③ Make sure the transmitter is not muted.
- **If sound of the unit is too low or too loud or even distorted**

Adjust mic gain and volume to the suitable level for recording in the current environment to improve the recording effect.
- **Current noise or other abnormal noise appears during monitoring**
 - ① Replace the connecting cable.
 - ② Make sure there is no interference near the unit. If the noise still exists after changing the unit's position, please contact our customer service.
- **Failed to communicate with the other party when using applications such as live stream, conference, or communication (the other party's voice cannot be heard via the 3.5mm monitor port)**

Make sure to connect your device to the receiver's USB-C port. The receiver's 3.5mm output port can only output audio but cannot communicate with the other party.
- **The operating range of the unit is limited and the sound is intermittent frequently**

Make sure there is no interference between the transmitter and receiver. If the intermittent sound still occurs frequently, please contact our customer service.
- **If the transmitter or receiver suddenly freezes up**

Press and hold the power button of the transmitter or receiver for 18 seconds to force the shutdown.

Other Accessories

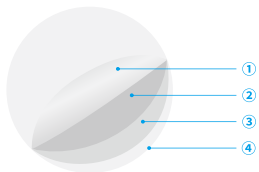

Screen Protector for Transmitter



Screen Protector for Receiver

- ① Remove it
- ② Clear the dust on the screen
- ③ Stick on the screen protector
- ④ Release liner

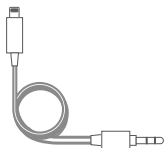

3.5mm TRS Male to Lightning Audio Cable (SR-C2000)

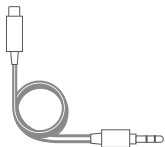

3.5mm TRS Male to USB-C Audio Cable (SR-C2001)

Contents of BlinkMe B2



2×
Transmitter



1×
Receiver



2×
Magnetic Clip



2× Fur
Windshield



4×
Magnet



1× 1/4" Magnetic
Cold Shoe Adapter

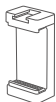

1× MVC
Phone Holder

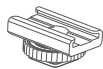

1× ZV-1
Adapter



1× 3.5mm TRS
Male to Lightning
Audio Cable



1× 3.5mm TRS
Male to USB-C
Audio Cable



1× 3.5mm TRRS
to 3.5mm TRRS
Audio Cable



1× 3.5mm TRS
to 3.5mm TRS
Audio Cable



1× USB-A to
USB-C
Cable



2× Screen
Protector
for Transmitter



1× Screen
Protector
for Receiver

声明

请在使用前仔细阅读本手册，并严格按照说明进行操作和存储。请妥善保存好说明书以供将来参考。如果用户手册不能帮助您解决某些问题，请向零售商寻求帮助或给我们发送电子邮件：info@saramonic.com

- 请勿擅自拆开机壳；
- 请勿将本机靠近热源，如加热器、烤箱或其他产生热量的设备；
- 电池不可自行更换；
- 请使用柔软的干布清洁本设备；
- 在使用和储存时，请注意防尘和防潮。

产品概述

枫笛BlinkMe为专业级双通道无线触屏麦克风系统，可以搭配不同的磁吸配件使用。轻巧便携，通用兼容电脑、相机、录音笔、混音器和其他音频/视频录制设备。非常适合内容创作者、电影制作人、记者、视频博主或主播等人群使用。

- 触屏操作，快捷直观
- 独立操作系统
- 智能板载录音功能
- 一键降噪，48kHz高清音质
- 一体式充电盒接收器
- APP自定义发射器显示图案
- 磁吸体系，配件丰富
- 任意吸附，随取随放

认识BlinkMe

TX发射器

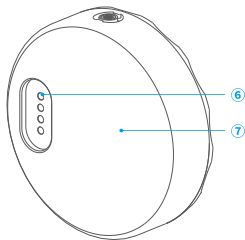
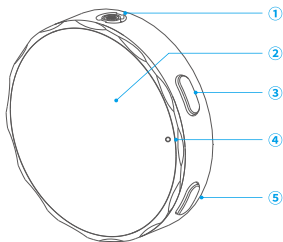

① 咪头

② 触摸屏

③ 电源键

长按3秒开/关机；双击锁屏/解锁。

④ LED指示灯

用于在发射器息屏时指示其状态。

指示灯	状态
蓝灯慢闪	未对码
蓝灯快闪	对码中
蓝灯常亮	对码成功
红灯慢闪	静音
红灯快闪	低电量
红灯常亮	充电中
红灯熄灭	充满电

⑤ NR键

短按开启/关闭降噪功能；

双击开启/关闭内录功能；

长按1.5秒静音/取消静音。

⑥ 触点

⑦ 磁吸区域

RX接收器

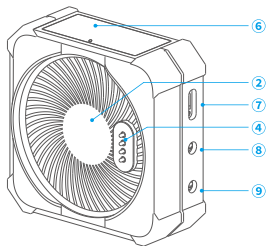
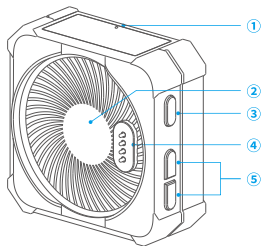

① LED指示灯

用于在接收器息屏时指示其状态。

指示灯	状态
蓝灯慢闪	未对码
蓝灯快闪	对码中
蓝灯常亮	对码成功
红灯快闪	低电量
红灯常亮	充电中
红灯熄灭	充满电

② 磁吸区域

③ 电源键

长按3秒开/关机;
双击锁屏/解锁。

④ 触点

⑤ +/-键

输出增益范围为-12dB至+12dB，短按+或-键以3dB/档调节接收器的输出增益电平。

⑥ 触摸屏

⑦ Type-C接口

用于充电和数据传输。

⑧ 3.5mm监听孔

接入耳机可进行音频监听。

⑨ 3.5mm自适应输出孔 (TRS/TRRS)

输出模拟音频至相机、手机、混音器等设备。

自定BlinkMe

TX发射器

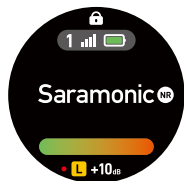









- 在主界面下，单击电源键可以亮屏或息屏。
- 在任一非主界面下，单击电源键可以返回主界面。
- 双击电源键，屏幕锁定/解锁的同时，将返回主界面。

	显示屏幕已锁定或已解锁 💡 建议锁定屏幕以避免在录制过程中误触； 设备在屏幕锁定时默认自动返回主界面
	发射器 1和接收器之间的无线信号强度； 灰色图标表示连接失败
	发射器电量
	降噪模式已开启
	音频输入电平 💡 当实时音量条渐变为红色时应调小发射器增益
	已静音
	内录功能已开启
	发射器输入增益
	左/右声道
	立体声/单声道/安全通道模式

在主界面上，从屏幕底部向上滑进入设备设置。上下滑动可以选择内录设置、降噪模式、增益调节、背光亮度、模式设置和系统设置。在设备设置中，点击  返回上级菜单。

	 REC保护	开启后，只能通过触屏关闭内录功能
	 自动录音	开启后，发射器开机将自动启用内录功能
	 位深	点击选择16bit或24bit位深
	<input checked="" type="radio"/> 原声模式	默认设定为原声模式，可按需选择原声模式或高清降噪模式
	<input type="radio"/> 高清降噪	
		拖动滑块精细调节发射器输入增益电平 (-12dB~+12dB) 调节发射器增益将影响本地录音音量的大小
		拖动滑块调节屏幕亮度
	<input checked="" type="radio"/> 省电模式	屏幕亮度调至50%；10秒内无操作将自动息屏（默认）
	<input type="radio"/> 常亮模式	屏幕保持常亮
	<input type="radio"/> 自定义	点击进入自定义界面，上下滚动设置自动息屏时间
	 设备配对	点击进入对码界面，发射器可与接收器配对
	 语言设置	点击选择一种语言
	 日期时间	点击设置日期与时间，录音文件会显示相应的信息
	 恢复出厂	点击将发射器恢复为默认设置，不清除内录文件和对码状态
	 版本	点击查看发射器的固件版本和序列号信息
	 认证信息	点击查看认证信息

在主界面上,从屏幕顶部向下滑,显示快捷设置。

 省电模式  常亮模式  自定义	点击切换
 静音开启  静音关闭	点击切换
 内录功能开启  内录功能关闭	点击切换
 系统设置	点击跳转

主题设置

1. 在主界面上,长按触摸屏;
2. 上下滑动屏幕可查看九种默认主题;
3. 点击屏幕应用所选主题。



扫描自定义壁纸上的二维码下载Saramonic APP,可以自行设置主界面背景图。

RX接收器

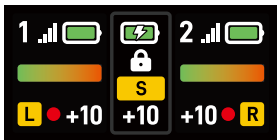





- 在任一非主界面下，单击电源键可以返回主界面。
- 双击电源键，屏幕锁定/解锁的同时将返回主界面。

	显示接收器屏幕已锁定或已解锁 💡 建议锁定屏幕以避免在录制过程中误触； 设备在屏幕锁定时默认自动返回主界面
	左右两边表示发射器电量，界面中间表示接收器电量
	接收器正在充电
	接收器正在给发射器充电
	接收器处于单声道模式/立体声模式/安全音轨模式
	左右两边表示发射器输入增益，界面中间表示接收器输出增益
	发射器1和接收器之间的无线信号强度
	发射器2和接收器之间的无线信号强度，不连接则不显示
	音频输入电平 💡 当时音量条渐变为红色时应调小发射器增益
	左/右声道 💡 立体声模式下，发射器1对应左声道，发射器2对应右声道
	内录功能已开启
	已静音

在主界面上,从屏幕顶部向下滑进入设备设置。左右滑动可以选择声道模式、RX增益、TX增益、模式设置和系统设置。在设备设置中,从屏幕底部向上滑返回上级菜单。

S	 M 单声道	左右声道输出的内容一致
	 S 立体声	左右声道输出分别对应发射器1和2两个声源
	 M 安全音轨	右声道的输出增益比左声道小6dB,以防止声音过爆
		拖动滑块,调节接收器输出增益电平(-12dB~+12dB) 若声音过爆,优先调小接收器增益值
		已配对状态下,点击左边或右边选择设置TX1或TX2。 拖动滑块,精细调节发射器输入增益电平(增益范围为-12dB至+12dB)。注意:调节发射器增益将影响本地录音音量的大小。
	 省电模式	屏幕亮度调至50%,10秒内无操作将自动息屏(默认)
	 常亮模式	屏幕保持常亮
	 对码	点击进入对码界面,接收器可与发射器配对
	 背光亮度	点击进入界面,拖动滑块调节屏幕亮度
	 语言设置	点击进入界面,左滑或右滑选择语言
	 恢复出厂	点击将接收器恢复为默认设置,不清除对码状态
	 版本	点击查看接收器的固件版本和序列号信息
	 认证信息	点击查看认证信息

在主界面上, 对应屏幕左侧或右侧向上滑动可以设置TX1或TX2发射器。

 内录开启	点击切换
 内录关闭	
 静音开启	点击切换
 静音关闭	
 内存	显示剩余可录音时间; 点击进入下级菜单
 格式化	点击清除发射器的内录音文件

使用BlinkMe

TX发射器

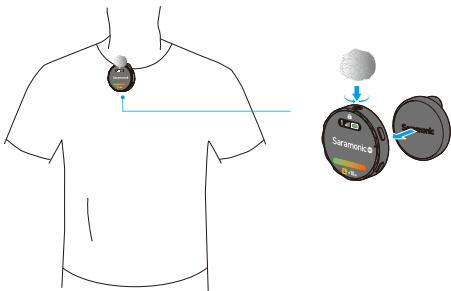

使用磁吸背夹佩戴发射器。

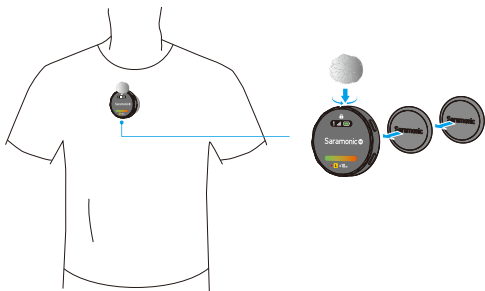

使用磁吸片佩戴发射器。

RX接收器

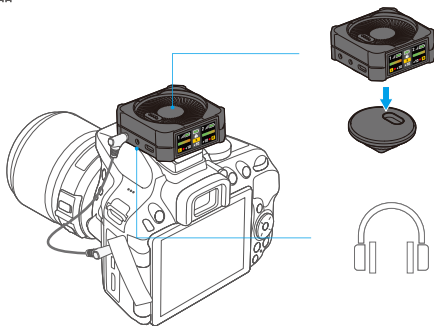

1. 使用适配音频线将相机、手机或电脑等设备连接至接收器的3.5mm自适应音频输出孔。
2. 根据需求，可接入您的耳机进行音频监听。

 当您使用的相机为SONY ZV-1、ZV-1 II、ILCE-7C机型时，请搭配随附的ZV-1冷靴转接座一起使用。

配对

发射器和接收器出厂前已配对成功。若其断开连接，请点击发射器和接收器的屏幕进入系统设置，点击“对码”进行重新配对。

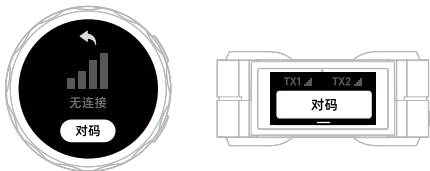

1. 当TX1、TX2都要与RX进行配对时，请优先设置发射器配对，最后设置接收器配对。
2. 如遇产品屏幕界面无法操作，请长按电源键18秒强制关机，再次长按电源键3秒开机即可。
3. 由于在2.4GHz频谱下，信号很容易受干扰，请尽量避开墙壁和建筑物等障碍物，避免接近2.4GHz频率的设备，如大功率Wi-Fi天线、收音机等。

充电

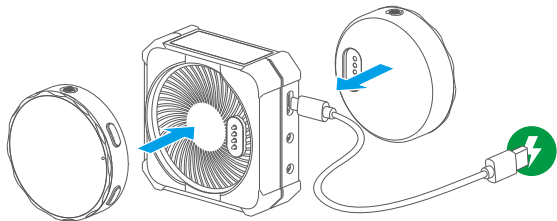

- 1、将发射器放入接收器，发射器将自动关机进行充电。
接收器达到安全电量后会停止给发射器充电。
- 2、当接收器处于低电量时，请使用随附的 USB-A转Type-C数据线的为接收器充电。

双设备输出

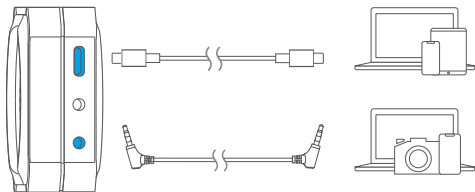

使用对应转接线将两个设备分别连接至接收器的3.5mm自适应输出孔和Type-C接口，可以同时进行音频输出。

内录功能

- 在48kHz/16bit采样率下，内存支持最大存储22小时的录音时长；
在48kHz/24bit采样率下，内存支持最大存储15小时的录音时长。
- 录音满30分钟后将自动分割文件，便于快速查找想要的录音片段。
- 录音文件默认命名格式为“年月日-时分秒.WAV”，最高支持999个录音文件。
- 内存录满后将自动循环覆盖。

💡 开启静音模式并不会影响板载录音功能。

读取文件

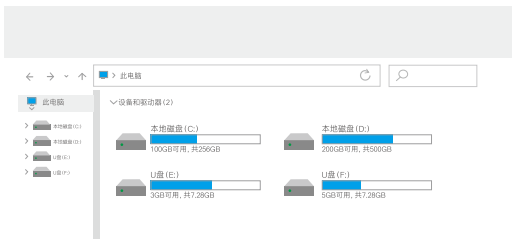
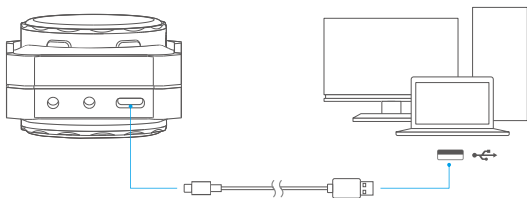

将两个发射器放入接收器后, 连接电脑至接收器的Type-C接口即可读取TX1/TX2的内录文件。(设备名称可在APP内更改。)

BlinkMe参数

屏幕	TFT
传输方式	2.4GHz数字频段
信号调制	数字调制
极性模式	全向型
天线	内置
使用距离(无障碍)	100米
射频输出功率	< 10mW
采样率	48KHz
频率响应	20Hz-20KHz
信噪比	>80dB
最大声压级	110dB SPL
灵敏度	-39±2dB
音频输入接口	TX: 内置电容麦克风
监听接口	RX: 3.5mm监听孔
音频输出接口	RX: 3.5mm自适应输出孔 (TRS/TRRS)
供电方式	内置锂电池
电池规格	TX: 3.85V/495mAh RX: 3.7V/1600mAh
充电接口	TX: 充电触点 RX: Type-C
充电时长	RX: 约2.5小时(使用5V/2A充电器)
续航时长	TX: 约5小时(内录功能开启) 约8小时(内录功能关闭) RX: 约24小时(给单个TX充满一次电)
内存容量	TX: 8GB
重量	TX: 30g RX: 70g
尺寸	TX: ø47×12.5mm RX: 56.6×56.6×25.2mm
工作温度	0°C ~ +50°C
贮存温度	-10°C ~ +50°C

故障排除

在使用本机的过程中出现任何问题，请参照以下内容加以解决。如果此手册仍然无法解决您遇到的问题，请与我们当地的经销商售后服务部联系。

- **产品无声音或连接设备无声音**

- ① 检查产品是否连接正常，线材是否有松动。
- ② 检查增益、音量是否被调至最低。
- ③ 检查发射器是否开启了静音功能。

- **产品声音过小或过大甚至破音**

通过调节增益、音量，找到最适合当前环境录制的档位，提高录制效果。

- **监听有不干净电流声/异常噪音等**

- ① 更换连接线。
- ② 请检查本机附近是否有干扰源；若本机更换使用位置后还是有噪音，请联系客服咨询。

- **直播/会议/通话等应用程序中无法与对方连麦、通话（监听孔听不到对方的声音）**

请将您的设备连接至接收器的Type-C接口。因为接收器的3.5mm输出孔只能输出音频，不能与对方连麦通话。

- **产品使用距离短、频繁断续**

产品的使用距离受限且声音频繁断续查看发射器、接收器之间是否有干扰源，将产品更换使用位置再次确认，若声音还是频繁断续，请联系客服咨询。

- **产品出现异常死机现象**

长按电源键18秒可以将产品强制关机。

其他配件

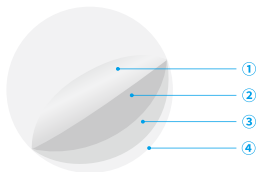

发射器水凝膜



接收器水凝膜

- ① 撕除
- ② 粘掉屏幕灰尘
- ③ 贴在屏幕上
- ④ 离型纸

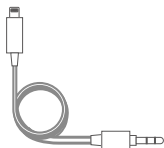

3.5mm TRS公头转Lightning
音频转接线 (SR-C2000)

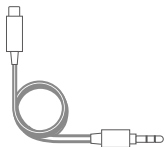

3.5mm TRS公头转Type-C
音频转接线 (SR-C2001)

BlinkMe B2包装清单



2×
发射器



1×
接收器



2×
磁吸背夹



2×
防风毛套



4×
磁吸片



1× 1/4"螺孔
冷靴座

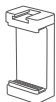

1×
MVC手机夹

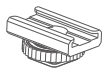

1×ZV-1冷靴
转接座



3.5mm TRS公头
转Lightning
音频转接线



3.5mm TRS公头
转Type-C
音频转接线



1× 3.5mm TRRS
转3.5mm TRRS
音频线



1× 3.5mm TRS
转3.5mm TRS
音频线



1× USB-A
转Type-C
数据线



2×发射器
水凝膜



1×接收器
水凝膜



For better recording experience, the application Saramonic is recommended.

为获得更好的录制体验, 推荐使用枫笛 Saramonic 自主研发应用软件 Saramonic。



Scan the QR code and follow us!

Shenzhen Jiayz Photo Industrial., Ltd
深圳市长丰影像器材有限公司

A16 Building, Intelligent Terminal Industrial Park of Silicon Valley
Power, Guanlan, Longhua District, Shenzhen, China
深圳市龙华区观澜街道大富工业区硅谷动力智能终端产业园A16栋

☎ 400-613-1096 🌐 www.saramonic.com ✉ info@saramonic.com